

anex modu

frame

Maintenance
Manual

Single configurations	5
Double configurations	7
Unfolding the frame	13
Folding the frame	14
Basket	15
Handle regulation	16
Front wheels attachment and detachment	16
Front wheels swivel lock	17
Rear wheels attachment and detachment	18
Brakes	19
Shock absorption	19
Adapters usage	20
Upper adapters	21
Lower adapters	22
Carry belt	23

Maximum weight

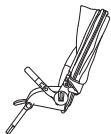

max. 22 kg



max. 13 kg

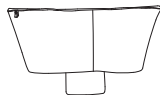

max. 2x22 kg

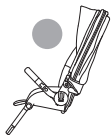

max. 15 kg

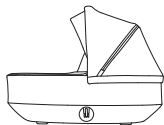

max. 9 kg

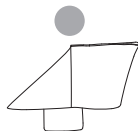

max. 22 kg

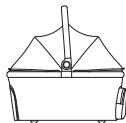

max. 15 kg



max. 10 kg



max. 2 kg

Single configurations (adapters in position ①)

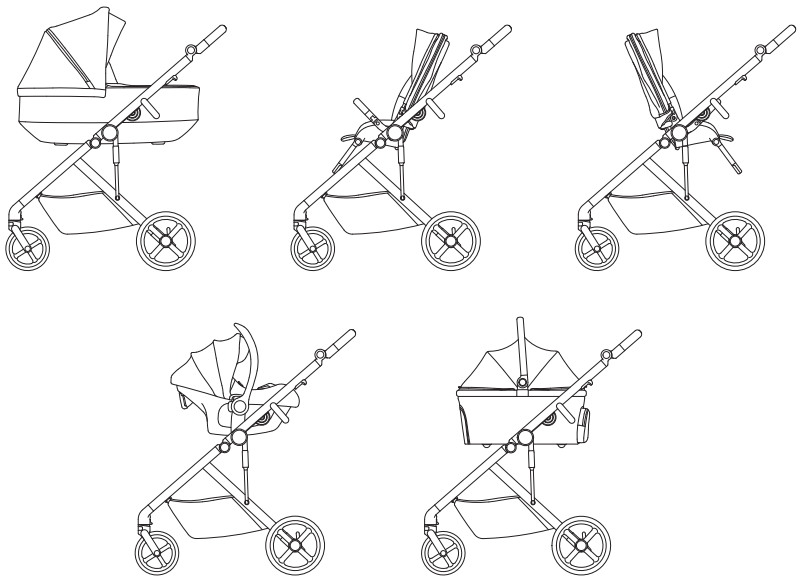

Single configurations (adapters in position ①)

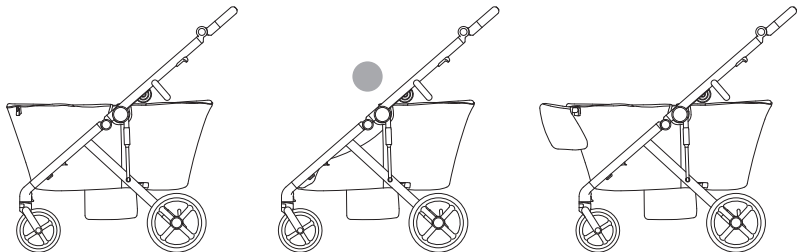

Double configurations (adapters in position Ⅱ + Ⅲ)

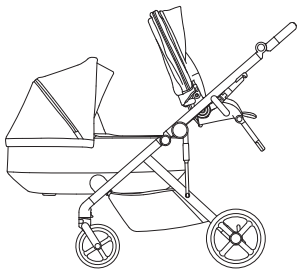
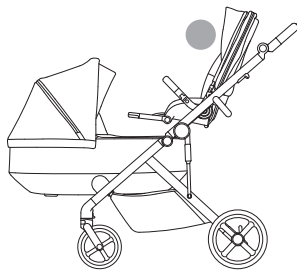
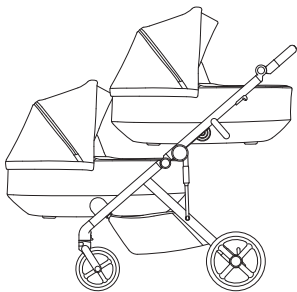

Double configurations (adapters in position Ⅱ + Ⅲ)

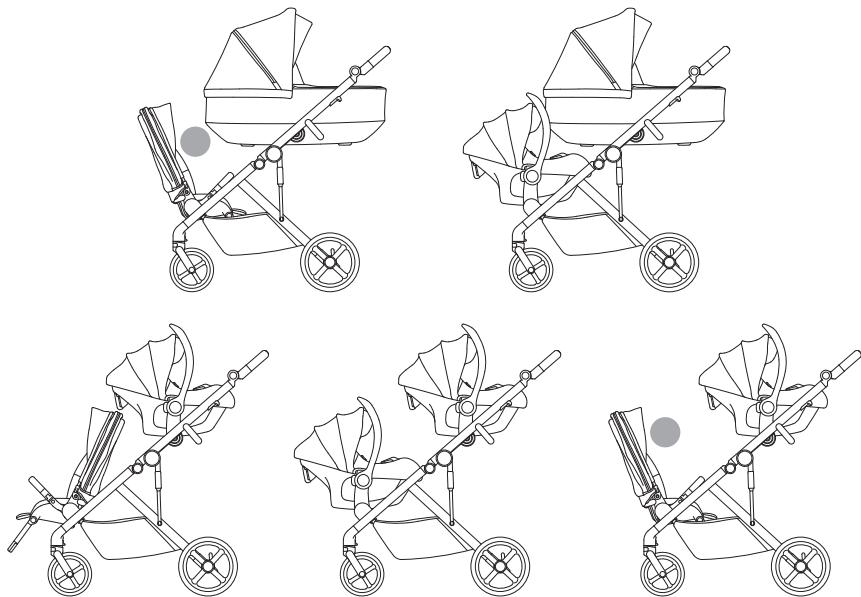

Double configurations (adapters in position Ⅱ + Ⅲ)

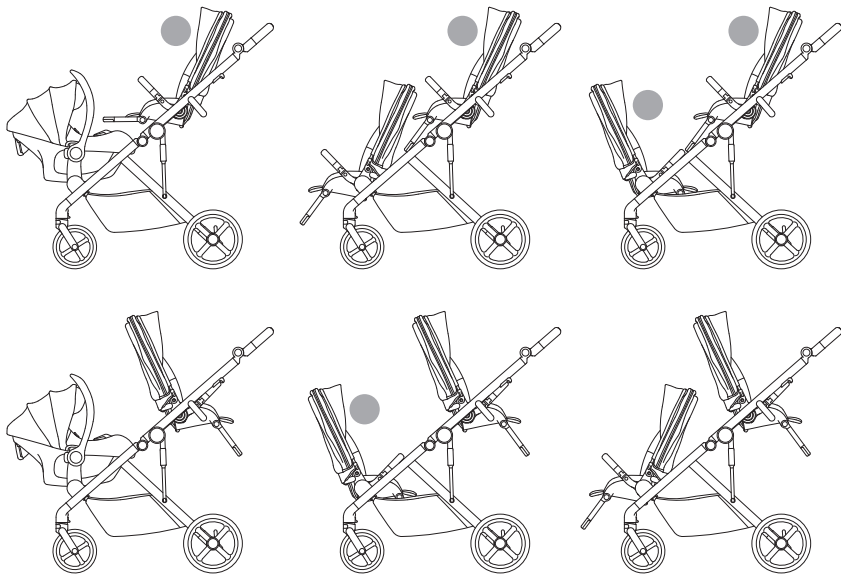

Double configurations (adapters in position Ⅱ + Ⅲ)

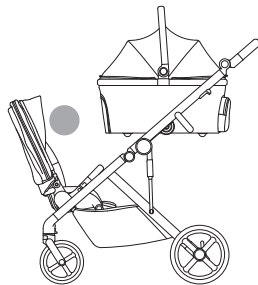
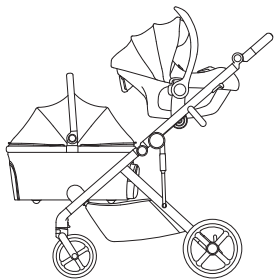
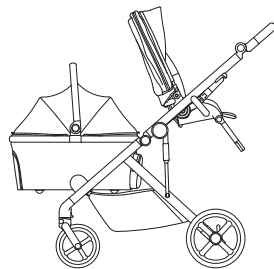
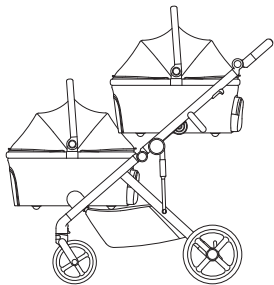

Double configurations (adapters in position Ⅱ + Ⅲ)

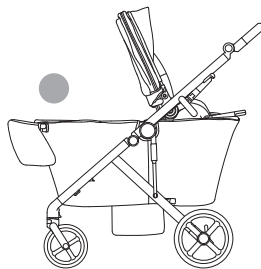
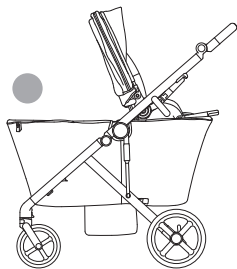
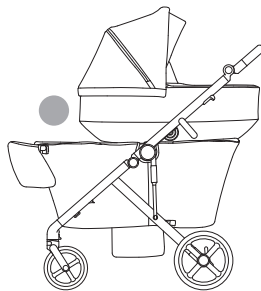
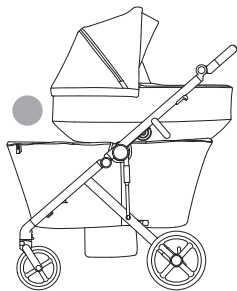

Double configurations (adapters in position Ⅱ + Ⅲ)

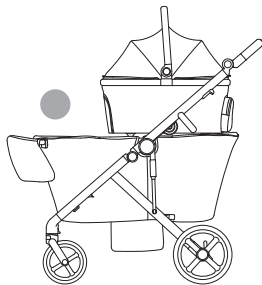
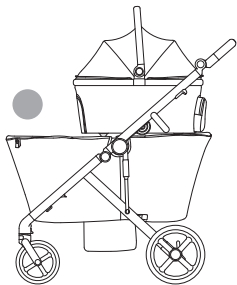
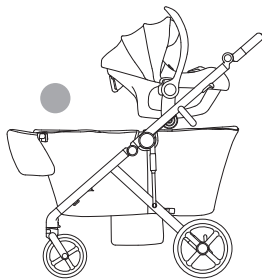

Unfolding the frame

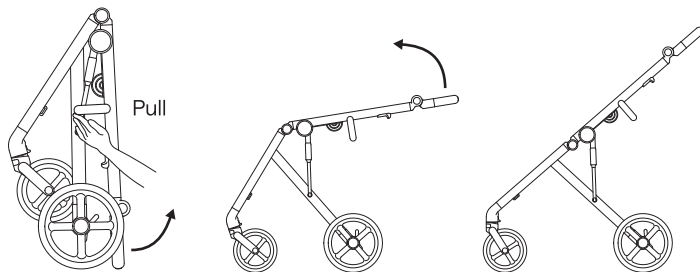

Folding the frame

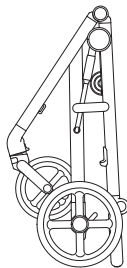
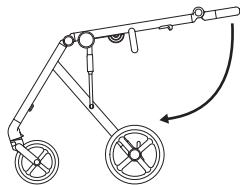
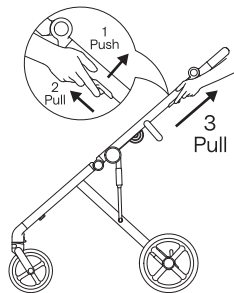
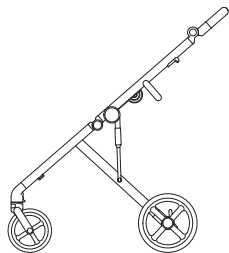

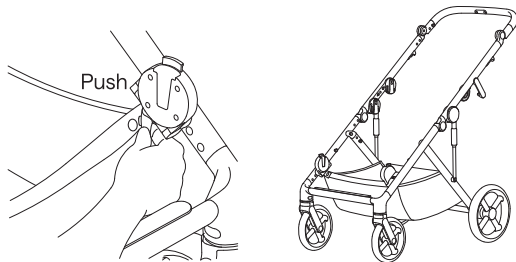
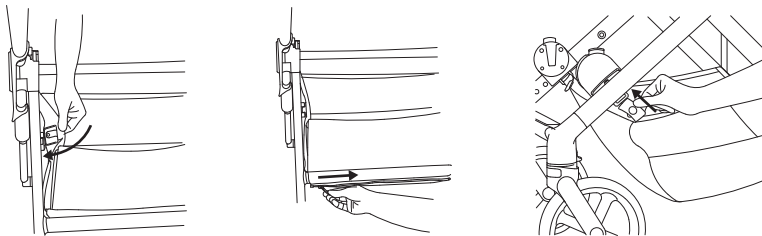

6

Handle regulation

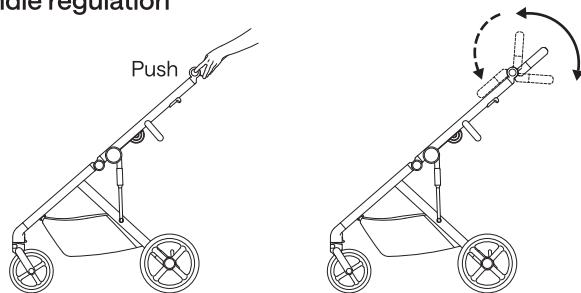

7

Front wheels attachment and detachment

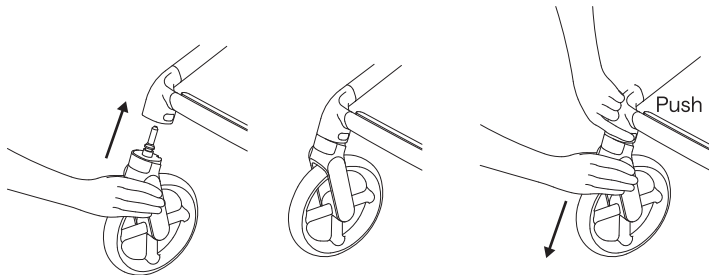

Front wheels swivel lock

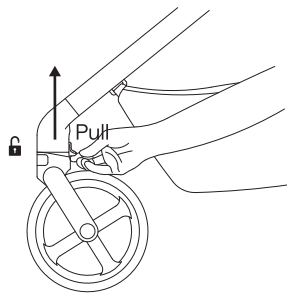
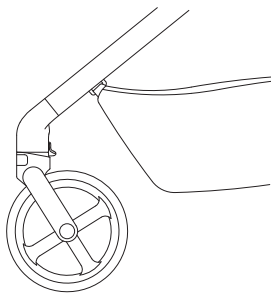
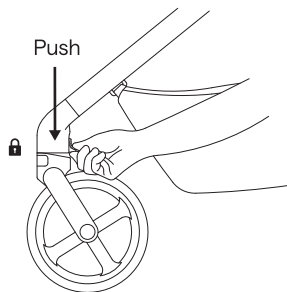
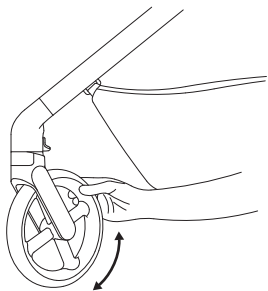

Rear wheels attachment and detachment

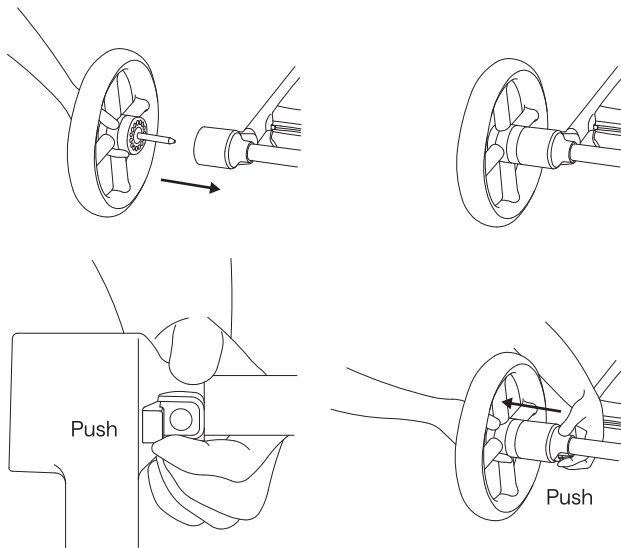

10

Brakes

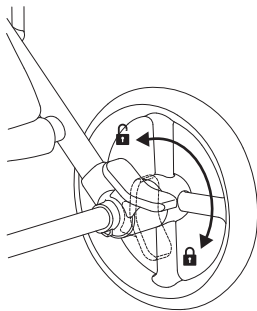

11

Shock absorption

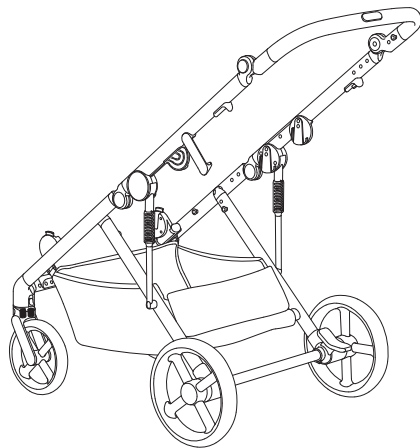

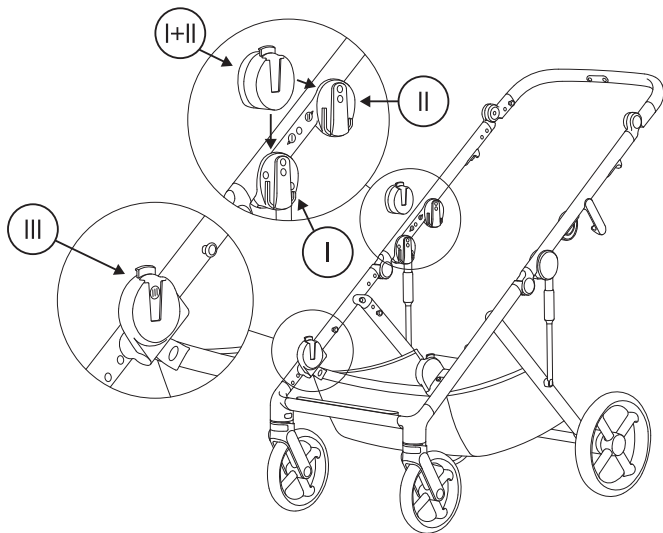

Upper adapters

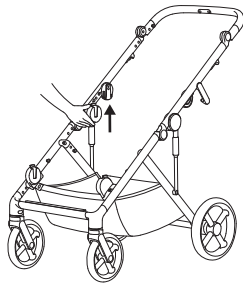
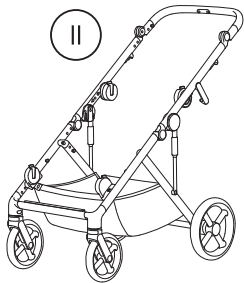
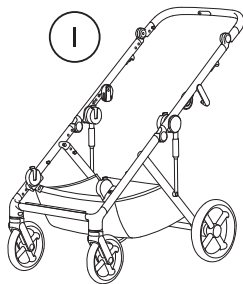
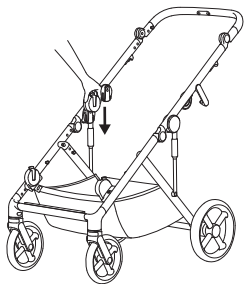

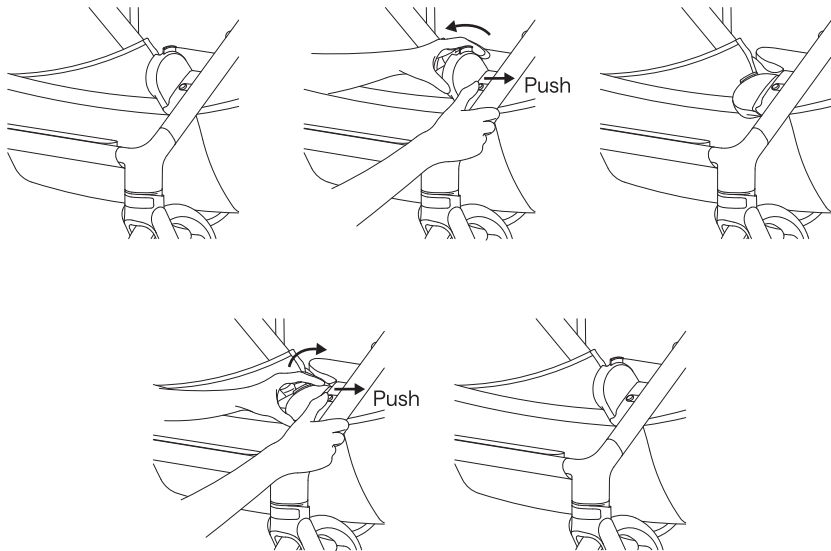

Carry belt

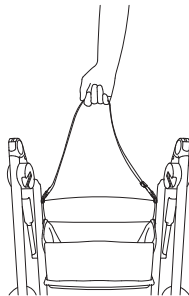
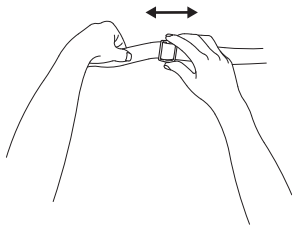
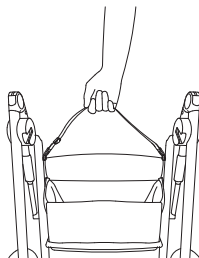
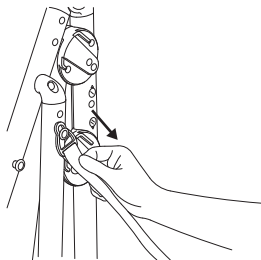



EN 1888-2:2018+A1:2022

Check for the most recent manuals
on our website: anexbaby.com

The information is subject to change without
notice. Anex shall not be liable for technical
errors or omissions contained in this manual.
The purchased product may differ from the
product as described in this manual.

AVALEX PTE. LTD.
114 Lavender Street, #08-58/59
CT Hub 2, Singapore 338729
+65 6518 9722
office@anexbaby.com

Importer and Economic Operator in the EU:
IDEO GROUP SPOLKA Z O. O.
Address: Al. Solidarnosci 117 lok. 207,
00-140 Warsaw, Poland
office@anexbaby.com